

## Study of Renewable Energy Installation Quality in the Renewable Energy Growth Program

**2019 STUDY**

October 28, 2019

**Prepared for:**

**Rhode Island Office of Energy Resources**

315 Iron Horse Way, Suite 101

Providence, RI 02908



**Prepared by:**  
Sarah Tyrrell  
Rachel Fernandez  
William Atkinson  
Neil Veilleux

# Table of Contents

- Acknowledgements.....1**
- Executive Summary.....2**
- Introduction .....3**
  - About the Renewable Energy Growth Program..... 3
- Study Goals.....5**
- Study Methodology .....6**
  - Study Preparation..... 6
  - Sampling Process..... 6
  - Inspection Process..... 7
  - Report Delivery and Installer Follow-Up ..... 10
  - Data Aggregation and Analysis..... 12
  - Small Solar PV System Findings ..... 13
  - Medium Solar PV System Findings ..... 23
  - Large Solar PV System Findings ..... 26
  - Wind Turbine System Findings ..... 28
  - Installer Responsiveness to Quality Installation Issues ..... 29
  - Customer Survey ..... 31
- Conclusions and Recommendations.....37**
  - High-Priority Recommendations ..... 37
  - Medium-Priority Recommendations ..... 38
  - Low-Priority Recommendations ..... 40
  - Progress on 2018 Recommendations..... 40
  - Additional Progress ..... 41
  - Next Steps..... 41

## Acknowledgements

The project team would like to thank Shauna Beland of the Rhode Island Office of Energy Resources and the Rhode Island Distributed Generation Board for their support and input prior to and during this study. The team would also like to thank the National Grid staff; without their support and willingness to provide key data, this study would not have been possible.

## Executive Summary

Cadmus, working under contract with the Rhode Island Office of Energy Resources (OER), is performing an independent installation-quality evaluation on projects installed through the Renewable Energy Growth (REG) program. A tariff-based program, REG supports the development of renewable energy systems across Rhode Island, with a goal of supporting 160 MW of renewable energy development.

As of October 2019, Cadmus completed 80 inspections on small-scale solar, eight medium-scale solar, and four large-scale solar photovoltaic (PV) systems as well as one wind energy system installed through the end of the 2019 REG tariff year. This report presents the results from these efforts. We performed inspections using a standardized inspection process and Cadmus' proprietary PV Quality Evaluation and Scoring Tool (PVQUEST)—a secure, online database application that tracks and reports on more than 800 of the most common PV installation deficiencies. Inspections focused heavily on compliance with codes and standards, including the National Electrical Code and the International Building Code. Cadmus conducted all inspections after each project received approval from the relevant authorities and permitting agencies.

This report includes the following key study findings:

- **Improving from the 2018 study where 47% of small-scale solar PV systems inspected exhibited major or critical installation deficiencies, this year's study found only 31% of inspected small-scale solar PV systems exhibited major or critical installation deficiencies.** Major and critical deficiencies include those expected to cause immediate or short-term system failure risks, reduce operating capacity, or pose a safety hazard.
- **Most installation deficiencies occurred at the PV array and at the interconnection point.** During the inspections, Cadmus encountered issues such as grounding, labeling, and wire management.
- **The average score quality improved from 2018 to 2019.** Quality scores under this study were, on average, 0.70 points higher than scores under the 2018 quality assurance study.

Based on these findings, Cadmus recommends making the following high-priority improvements to support increased installation quality for the REG Program. Cadmus considered recommendations as high priorities if they had higher anticipated impacts and shorter implementation timelines (i.e., less than six months).

- **Collect and report additional data related to installation quality**, specifically license information and production estimate.
- **Offer training to local electrical and building inspectors** to address potential onsite issues before final system approval.
- **Offer training to renewable energy installers**, tailored to commonly cited issues and changes in the NEC.

## Introduction

This report presents the results of Cadmus' study reviewing the quality of renewable energy installations funded by the Renewable Energy Growth (REG) program in Rhode Island through the 2019 tariff year. The Rhode Island Office of Energy Resources (OER) commissioned this study on behalf of the Rhode Island Distributed Generation Board (Board). These results drew upon Cadmus' on-site inspections of 80 small-scale solar photovoltaic (PV) installations, eight medium-scale solar PV installations, four large-scale solar PV installations, and one wind installation. In 2018, Cadmus completed a similar installation quality study, with the results published by the Rhode Island Public Utilities Commission (PUC) and OER.<sup>1</sup>

The 10-member Board, representing different stakeholder interests, oversees the REG program. The Board includes three non-voting members—representatives from National Grid, the OER commissioner, and a representative from the Renewable Energy Fund (REF) at the Rhode Island Commerce Corporation.

### *About the Renewable Energy Growth Program*

In 2014, the Rhode Island General Assembly voted to create the REG program. Tariffs govern program participation, expanding upon the prior Distributed Generation Contracts program. The REG program enables customers to sell renewable energy generation output at fixed prices and under long-term tariffs. To facilitate this incentive structure, the REG program delineates renewable energy classes by technology types and sizes. For each class and size delineation the REG program specifies an enrollment target capacity, a performance-based incentive, and/or a ceiling price. National Grid's website publishes annual enrollment targets and incentive levels.<sup>2</sup>

Two general projects categories delineate the program:

- **Small-scale solar (25 kW or less).** The program accepts applications during a continuous open enrollment. The tariff's duration lasts 15 or 20 years.
- **Larger-scale solar (greater than 25 kW), wind, hydroelectric, and anaerobic digesters.** The program accepts applications three times per year, during two-weeklong open enrollment periods. The tariff's duration lasts 20 years.

---

<sup>1</sup> The Cadmus Group, LLC. *Study of Renewable Energy Installation Quality in the Renewable Energy Growth Program*. 2017. Available online: [http://www.ripuc.org/eventsactions/docket/4604-OER-Cadmus-Study-InstallationQuality\(11-14-17\).PDF](http://www.ripuc.org/eventsactions/docket/4604-OER-Cadmus-Study-InstallationQuality(11-14-17).PDF) & <http://www.energy.ri.gov/policies-programs/programs-incentives/reg-program.php>

<sup>2</sup> National Grid. *Rhode Island Renewable Energy Growth Program*. Date accessed May 2018. Available online: [https://www9.nationalgridus.com/narragansett/business/energyeff/4\\_dist\\_gen.asp](https://www9.nationalgridus.com/narragansett/business/energyeff/4_dist_gen.asp)

## Renewable Energy Growth Program Minimum Technical Guidance (MTG)

Cadmus worked with OER to develop minimum technical requirements<sup>3</sup> for this program and identified minimum codes and standards applicable to installations in Rhode Island. Additionally, this effort also outlined some of the most common, often overlooked violations.

---

<sup>3</sup> Rhode Island Office of Energy Resources. *Minimum Technical Guidance for the Renewable Energy Growth (REG) Program*. 2019. Available online: [http://www.energy.ri.gov/documents/renewable/RI-REG-Minimum-Tech-Guidance\\_2019.pdf](http://www.energy.ri.gov/documents/renewable/RI-REG-Minimum-Tech-Guidance_2019.pdf)

## Study Goals

This study seeks to determine the quality of REG-funded renewable energy installations through REG program year 2019. OER requested that the study determine whether REG-funded renewable energy installations were “safe, high-quality, performing as expected, and in conformance with the stated specifications.”<sup>4</sup> To address this, Cadmus used the following research questions to guide the team’s quality assurance (QA) efforts.

**Table 1. REG Study Goals**

Cadmus Research Questions for the REG Installation Quality Study
<p>What is the quality of renewable energy installations across technologies, system sizes, and installers?</p> <ul style="list-style-type: none"> <li>• Base inspection results, using Cadmus' 1 to 5 quality scale.</li> <li>• Analysis across a project sample, drawn from small-, medium-, and large-installation firms, including self-installers.</li> <li>• A sample from installations in REG tariff years 2018 and 2019.</li> <li>• Analysis across technologies, including small-solar PV, medium-solar PV, large-solar PV, and wind.</li> </ul>
<p>What are the most common and serious installation issues identified?</p> <ul style="list-style-type: none"> <li>• Summarize data by inspection elements, such as array, interconnections, or inverters; by issue severity, ranging from incidental to critical; and by issue types, such as labeling, grounding, or structural.</li> </ul>
<p>Are REG Installers addressing identified violations? If yes, what is the timeline?</p> <ul style="list-style-type: none"> <li>• Analyze the likelihood of installers' responses to identified violations in addition to the likelihood for completing satisfactory corrections.</li> <li>• Assess the timeline for installer responsiveness, from initial receipt of the inspection report to completion of the required corrective actions.</li> </ul>
<p>Based on the quality assurance study findings, would the REG program benefit from ongoing QA reviews to ensure long-term safety and productivity of funded renewable energy systems?</p> <ul style="list-style-type: none"> <li>• Assess from the results of the program-wide average quality score.</li> <li>• Inform by the frequency and severity of installation issues found.</li> </ul>

---

<sup>4</sup> OER specified the metric in RFP 7549810, *Solar Quality Assurance Inspection Study and Report*. 2015.



## Study Methodology

### Study Preparation

In preparation for this study, Cadmus discussed study methodology and goals with OER and National Grid which informed the development of our study approach, discussed below. The study methodology drew upon Cadmus’ decade of experience inspecting solar energy systems, OER’s and National Grid’s input, and REG programmatic documents.

Specifically, Cadmus referred to REG Program Tariff documents (RIPUC No. 2151-B and 2152-B),<sup>5</sup> which outlined the REG program’s rules and regulations. These documents provided Cadmus and OER with a basis for determining quality assurance program rules and development of the *Minimum Technical Guidance for the Renewable Energy Growth Quality Assurance Program*.

### Sampling Process

Cadmus recommended distributing inspections across technologies, system sizes, and installers to determine a sample selection, with each technology type and size receiving two inspections per installer. Table 2 lists the target number of inspections and installers for each technology type and size.

**Table 2. REG Installation Quality Study Sample Selection**

Task	Projected Number of Inspections	Projected Number of Installers	Actual Number of Inspections	Actual Number of Installers
Small Solar Inspections	87	38	80	36
Medium Solar Inspections	8	2	8	3
Large Solar Inspections	4	4	4	4
Wind Inspections	1	1	1	1
<b>Total</b>	<b>100</b>	<b>45</b>	<b>93</b>	<b>44</b>

Within each technology type and size, Cadmus and OER sought to inspect systems completed by a variety of installers. For example, OER directed Cadmus to specifically inspect small solar systems that had been self-installed by the owner of a residence.

For small-scale solar installations, the study team selected sites using a random-proportional, stratified sampling technique, based on the number of operational installations per installer. In a proportional stratified sample, the total population’s percentage in each stratum matches, as closely as possible, the

---

<sup>5</sup> The Narragansett Electric Company. *Renewable Energy Growth Program for Residential Customers*. 2016. Available online: [https://www9.nationalgridus.com/narragansett/non\\_html/Clean-RE%20Growth%20Residential%20Tariff%20Revisions%20\(PUC%208-12-16\).pdf](https://www9.nationalgridus.com/narragansett/non_html/Clean-RE%20Growth%20Residential%20Tariff%20Revisions%20(PUC%208-12-16).pdf)

The Narragansett Electric Company. *Renewable Energy Growth Program for Non-Residential Customers*. 2016. Available online: [https://www9.nationalgridus.com/narragansett/non\\_html/Clean-RE%20Growth%20Non-Residential%20Tariff%20\(PUC%208-12-16\).pdf](https://www9.nationalgridus.com/narragansett/non_html/Clean-RE%20Growth%20Non-Residential%20Tariff%20(PUC%208-12-16).pdf)

proportion of individuals actually sampled in that stratum. In this case, Cadmus sought to sample installations from every small solar installer enrolled in the REG program, while maintaining the sample’s statistical integrity. This meant that the number of sites selected per installer had to match each installer’s relative percentage of total sites in the program. This allowed Cadmus to apply the study’s results to the program on a broader scale. Table 3 shows the inspection target numbers for each installer type and size.

Though the site-selection process targeted the primary installer of each renewable energy installation, primary installers commonly subcontract installation work. This study could not track the installation quality by subcontractor due to data limitations in the interconnection application.

**Table 3. Small Solar Statistical Sampling Methodology**

Installer Category	Projected Sample Size
Large Installer (>22 installs)	5-7
Medium Installer (15-22 installs)	3-4
Small Installer (<15 installs)	1-3

## Inspection Process

### Inspection Scope of Work

As noted, OER selected Cadmus as the technical consultant to study the quality of renewable energy installations receiving incentives through the REG program. Our role included performing all study aspects, from study design to data collection to data analysis and reporting. We worked closely with OER staff to solidify the study’s methodology and approach, and our team met with National Grid staff to present the study approach. All on-site inspections of renewable energy systems addressed through the study were completed by Cadmus or its subcontractor, Ridgeline Analytics.

A component of Cadmus’ inspection, unique to the REG program, included reviewing each system’s dedicated utility meter—separate from a premise’s existing meter—as required by Section 4 of the REG Program tariff document (RIPUC No. 2151). Specifically, Cadmus’ inspection noted that no electrical connections should be made on an existing utility meter’s load side.

To ensure that a robust study sample presented a level playing field for all installers, Cadmus did not conduct desktop inspections as part of this study. During on-site inspections, our inspectors collected all relevant data using a tablet-based application and provided these system-specific reports to OER on an ongoing basis. Lastly, the study results, presented in this report, aggregates all data, provides preliminary findings, and offers recommendations for OER’s and National Grid’s next steps.

### Customer Outreach and Scheduling

Cadmus and its subcontractors scheduled and conducted all inspections with system owners. During project planning for our previous 2018 REG study, National Grid raised an important issue: the need to

remain cognizant of customers’ perceptions regarding inspections for this utility-funded incentive. As such, Cadmus developed a standard operating procedure that our inspectors used in communicating with customers. The procedures describe how Cadmus staff would conduct itself before, during, and after the inspections.

## Input Data Sources

To ensure information required for this study could be easily shared, Cadmus entered into a nondisclosure agreement with OER and National Grid. All data on renewable customers and their energy systems originated from National Grid’s data. OER received these data, subsequently passing them on to Cadmus, allowing the team to effectively conduct inspections. Table 4 lists data Cadmus received prior to inspections.

**Table 4. Pre-Inspection Data Reviewed by Cadmus**

Data Type	Description
System Owner Information	<ul style="list-style-type: none"> <li>Owner name, address, email, and phone number</li> </ul>
System General Information	<ul style="list-style-type: none"> <li>System address</li> <li>Developer and contact information</li> </ul>
System Equipment Information	<ul style="list-style-type: none"> <li>Solar PV module manufacturer, model, and number of PV modules</li> <li>Inverter manufacturer, model, and number of inverters</li> <li>Nameplate rating</li> <li>Wind energy system manuals and system specifications</li> <li>Wind energy system site plans</li> <li>Wind energy system one-line diagrams</li> </ul>
Tariff-Specific Details	<ul style="list-style-type: none"> <li>Date certificate of eligibility issued</li> <li>Tariff year and term</li> <li>Commercial operation date</li> </ul>
Costs and Fees	<ul style="list-style-type: none"> <li>Total project cost</li> <li>Electrical permit fee</li> <li>Building permit fee</li> </ul>

## On-Site Data Collection

To provide timely reporting and tracking of renewable energy inspections, Cadmus used its PVQUEST platform, a database platform that Cadmus developed to collect, categorize, analyze, and resolve over 800 of the most common solar PV installation issues. Using data collected through thousands of PV inspections, Cadmus programmed PVQUEST with the most common and serious installation issues.

For the REG study, PVQUEST provided a customized checklist of inspection issues, specific to each major system component (e.g., microinverters, direct current [DC] disconnects, load-side connections, subpanels). Consequently, PVQUEST’s highly specific inspection fields ensured that each inspector met the same standards, to the extent possible.

In using PVQUEST for field inspections, Cadmus team inspectors adhered to the following steps:

- Imported site and system data into PVQUEST
- Completed inspections using PVQUEST, running on a tablet computer

- Uploaded the inspection report to a secure cloud database

Upon uploading the data to a secure database, an engineering manager reviewed the inspection report and approved it or (if applicable) submitted a Corrective Action Report (CAR) to the installer for corrections. The tool stored and summarized the inspection data in various PVQUEST data tables for future reference.

**Figure 1. Overview of PVQUEST Data Flow and Outputs**

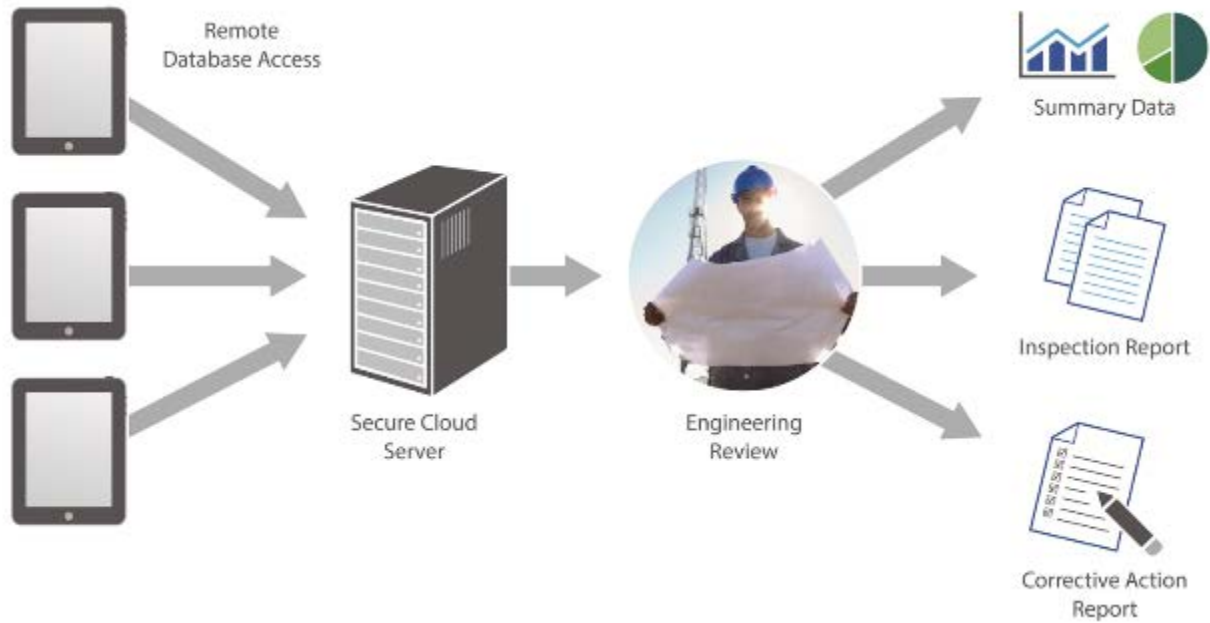

Based on violations identified during on-site inspections, PVQUEST generated a quality score, which Cadmus used to determine the quality of each inspected system. Table 5 lists defect categories or severities assigned to each inspected installation, along with typical scores for each type of installation issue.

**Table 5. PVQUEST Inspection Scoring System**

Defect Category	Description	Typical Score for Systems with Such Issues
No Issues	<b>No issues identified on site.</b>	<b>5</b>
Incidental	<b>Issues not expected to impact system operations or safety.</b> Examples: Installation debris left on site, poor wire management, missing or incomplete labels, and installed equipment not matching program records, but considered equivalent.	<b>4</b>
Minor	<b>Issues posing a mid- to long-term risk of system failure or safety hazards.</b> Examples: Bonding neutral-to-ground in a meter enclosure, insufficient clearance around boxes, undersized circuit protection, and improperly supported conductors.	<b>3</b>
Major	<b>Issues deemed likely to affect system performance or safety in the short-term, though not presenting an immediate hazard.</b> Examples: Missing equipment grounding, module damage, missing or undersized grounding electrode conductors, improperly secured PV modules, and missing or inadequate thermal expansion joints in long conduit runs.	<b>2</b>
Critical	<b>Issues posing an immediate risk of system failure and/or safety hazards. During inspections, systems often must be shut down due to safety concerns.</b> Examples: Exceeding current limits on busbars or conductors, exceeding inverter voltage limits, and use of non-DC rated equipment in DC circuits.	<b>1</b>

For example, a PV system with incidental issues would generally score a four out of five on the PVQUEST scoring scale. The algorithm, however, allows some adjustments. For example, if there are a large quantity of incidental issues a score of three rather than four would result. Only systems with major or critical deficiencies can receive the lowest score: a one out of five.

Inspectors base their observations on compliance with the 2014 National Electrical Code, relevant standards, and manufacturer installation instructions.<sup>6</sup> Cadmus did not evaluate systems against installation best practices or other, more subjective metrics. While useful to the industry, these metrics lack the consensus and rigor of code-making processes; hence, Cadmus did not reference them as an inspection basis for this study.

## Report Delivery and Installer Follow-Up

### Inspection Reports

Cadmus’ PVQUEST application automatically stored and compiled inspection data as the inspections occurred. As such, our team could generate draft site-specific inspection reports quickly, allowing

---

<sup>6</sup> Rhode Island adopted NEC17 on August 1, 2019, however all inspections under this study occurred on installations that were installed prior to this date.

delivery of results to installers in a timely fashion—particularly when identifying hazardous violations. Along with the final inspection report, Cadmus included a template CAR for installers (as described above). We asked installers to complete the CAR by documenting modifications they made to address identified violations and return the completed CAR for Cadmus' review and processing. Appendix C provides a sample PVQUEST inspection report and CAR. OER received all inspection reports and CARs via a secure SharePoint site.

## Procedures for Follow-Up with Installers

Given that the REG program provides a production-based incentive and not an upfront grant or rebate incentive, Cadmus anticipated issues would arise with installers not addressing identified violations in a timely fashion. Therefore, we limited follow-up on identified violations with installers or other contacts to a one-month period following an inspection's completion, reaching out to installers and/or contacts once a week for three weeks following an inspection.

To ensure consistent communication with installers, Cadmus used template emails, sent from a shared study-specific email account. This ensured installers would always receive information from a specific sender of any given inspection report. Consequently, all installers would receive, to the extent possible, the same information. We also used follow-up template emails, sent on each of three subsequent weeks, starting one week after delivery of the inspection report.

If Cadmus did not receive notice that appropriate parties addressed violations four weeks after the inspection, we sent the installer, system owner, and OER the finalized inspection report, citing outstanding violations. Cadmus instructed the installer to report any subsequent corrections to OER.

Additionally, the Cadmus team tracked the time between receiving an inspection report and submitting acceptable evidence of corrections for each system inspected. We handled communications through the shared email account, allowing the study team to easily track correspondence time stamps, address questions, and otherwise manage communications with system installers.

For example, many installers responded to the initial report and CAR email (e.g., indicated through self-certification that they had scheduled corrections or otherwise acknowledged receipt of Cadmus' report). For this study, Cadmus tracked dates of initial responses and dates when installers submitted acceptable corrections and reported these results separately. In some cases, the first response from an installer included the submittal of corrections, noted by an identical response and corrections date.

Through this process, Cadmus assessed the following responsiveness elements:

- Installer response time, from the initial report and CAR delivery to acknowledgment of receipt
- Installer response time, from the initial report and CAR delivery to the corrections submission
- Number of follow-up reminders required before receiving final corrections
- Number of follow-up reminders required before receiving acknowledgement of receipt
- Likelihood of final correction submissions within 30 days

## *Data Aggregation and Analysis*

Primary analysis completed through this study related to calculating the frequency of identified installation deficiencies; in other words, “How often did the study team find each given installation issue?” As noted in our study methodology, Cadmus attempted to stratify the sample to represent a broad mix of installation firms and to apply these findings to the REG program’s entire portfolio of small-scale projects.

### **Key Metrics for Measuring Installation Quality**

The PVQUEST score given to each inspected project served as the most frequently used metric for determining installation quality. Cadmus calculated a variety of summary statistics using that score, including:

- Average PVQUEST score for the study sample
- Weighted average PVQUEST score for the program population
- Average PVQUEST score by installer (and the installer’s category)

In addition, Cadmus tracked and reported several other relevant metrics:

- Average time (calendar days) for initial responses to inspection reports
- Average time (calendar days) for installers to successfully correct installation issues
- Percentage of inspected systems with issues unaddressed after 30 days
- Feedback from customers, installers, and other REG program stakeholders

### *Most Common Installation Deficiencies*

In PVQUEST, each deficiency has a unique identification code. Users can track, count, and summarize all 800 unique installation defects in the database independently. This provided multiple analysis options and allowed the Cadmus team to derive detailed statistics about common installation issues. For this study, we defined “most common” issues as those with the highest number of observations across the inspected sites. Consequently, a disconnect grounding issue, identified 50 times, would rank as more common than a labeling issue found 40 times among the same group of sites.

In addition to unique identifiers, Cadmus associated each deficiency with a system component (e.g., PV array, alternating current [AC] disconnect, supply-side connection) and with an issue type (e.g., grounding, labeling, workmanship). This allowed the team to not only categorize the most common specific deficiencies, but to identify where most deficiencies occurred within the system. This information may be used by stakeholders to target their training and internal QA efforts accordingly (e.g., focus on array wire management issues).

### **Assessment of Installer Responsiveness to Quality Issues**

Cadmus records and tracks installer responsiveness through its shared REG inspections email account and ongoing data tracking. We record any responses from installers or correspondence between Cadmus and an installer, which range from brief emails confirming receipt of reports to detailed conversations about ways to approach cited corrections. Upon receiving corrections via email, a Cadmus

inspector reviews and approves the corrections, and then marks the site as “completed” in the tracking system.

## Study Findings

From June to August 2019, Cadmus completed 92 solar PV system inspections and one wind inspection. All systems inspected fall within the 2018 and 2019 Tariff years.

### Small Solar PV System Findings

Of the 93 inspections, Cadmus completed 80 small-scale solar PV system inspections.

#### Overall Small Solar Installation Quality Scores

Cadmus calculated the average quality score for small solar projects inspected through this study. Overall, approximately 31% of inspected systems received a quality score of 1 or 2, indicating the presence of major and/or critical installation deficiencies, as shown in Table 6 and Figure 2.

**Table 6. Small Solar Quality Score Summary**

Solar Quality Score Summary, n = 80		
Score	Inspection Criteria	Count
1	System has critical and/or multiple major deficiencies	7
2	System has at least one major deficiency	18
3	System has multiple minor deficiencies	13
4	System has minor and/or incidental deficiencies	26
5	System as no or only incidental deficiencies	16

**Figure 2. Summary of Small Solar Quality Results by Five-Point Inspection Score (5 = No Issues), n=80**

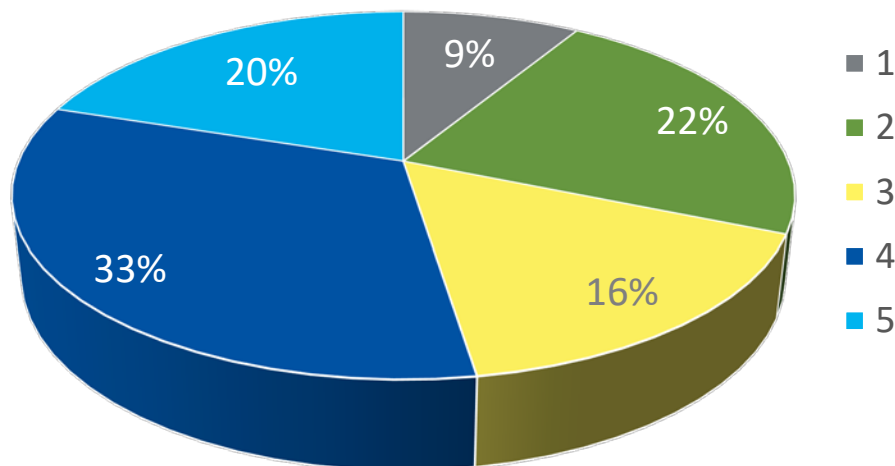



As Cadmus designed the sampling process to distribute study resources across as many installers as possible, the average score does not truly represent the actual population of projects installed under the REG program; rather, it represents the average across projects inspected for this study.

To convert this estimate into an estimate of program-wide installation quality, Cadmus calculated the average score per installer, and then averaged those scores using a weighting factor based on each installer’s quantity of projects completed under the REG program. This program-wide weighted average placed greater emphasis on higher-volume installers, presenting a more realistic assessment of the program-wide installation quality than the average calculated across the study sample. The program-wide weighted average score was 3.43. This result is higher than the unweighted average score of inspections conducted during the two-month study period, 3.33, as shown in Table 7.

**Table 7. Inspection Results During the Study Period**

Inspection Month	Total Inspections	Count by Quality Score					Average Score
		1	2	3	4	5	
June 2019	62	5	13	8	22	14	3.44
July 2019	18	2	5	5	4	2	2.94
<b>Totals</b>	<b>80</b>	<b>7</b>	<b>18</b>	<b>13</b>	<b>26</b>	<b>16</b>	<b>3.33</b>

<sup>1</sup> The *raw* average score—3.33—was calculated using the unweighted inspection scores. The *total* average score—3.43—represents the weighted average of all inspections, based on the quantity of REG projects completed by the installer.

### *Score by Installer*

Through the study’s course, the average quality score per installer varied significantly, with the lowest-scoring installers averaging 1.0 and the highest-scoring installers averaging 5.0.

### **Low-Volume Installer PV Systems**

Approximately 15 of 80 small solar inspections addressed systems installed by low-volume installers. Cadmus defined low-volume installers as those with fewer than eight operational REG projects throughout tariff years 2018 and 2019. Installations from low-volume installers totaled 43 operational projects out of 906 operational REG projects at this study’s initiation. During the 2019 study, Cadmus completed 15 low-volume installer inspections, resulting in an average score of 3.33.

These low-volume installations did not exhibit variance in quality scores compared to others inspected in the study, which is an improvement from year’s past.

**Table 8. Inspection Scores for Low Volume Installers**

Installer ID	Number of Inspections	Average Inspection Score
1004	1	4
1016	1	4
1031	2	2.5
1062	4	4
1065	1	4
1067	2	3.5
1072	2	3
1075	1	1
1078	1	4

### *Most Common Installation Issues*

In the 80 inspections completed, Cadmus found 363 installation issues, with 276 of these violating relevant codes and standards.

Most issues occurred at the array. The array and supply side interconnection points also exhibited the majority of *major and critical deficiencies*. Additionally, Cadmus found a significant number of issues at the inverter and AC-combiner elements.

**Table 9. Summary of Inspection Issues Found by Defect Category and Inspection Element**

Inspection Element	Recommendation	Incidental	Minor	Major	Critical	Total
AC Combiner	0	61	4	1	0	66
AC Disconnect	0	3	1	0	0	4
Array	0	43	24	10	0	77
Inverter	0	47	25	4	0	76
Junction Box	0	8	8	2	0	18
Optimizer	0	0	5	0	0	5
Overall Observations	5	10	0	0	0	15
Production Meter	0	1	7	0	1	9
Rapid Shutdown Device	0	3	3	0	0	6
<b>Total</b>	<b>5</b>	<b>176</b>	<b>77</b>	<b>17</b>	<b>1</b>	<b>363</b>

## Examples of Common Installation Deficiencies

In this section, Cadmus summarizes the most common installation deficiencies found through the study.

### Grounded Conductor Incorrectly Bonded to PV Service Disconnect Enclosure

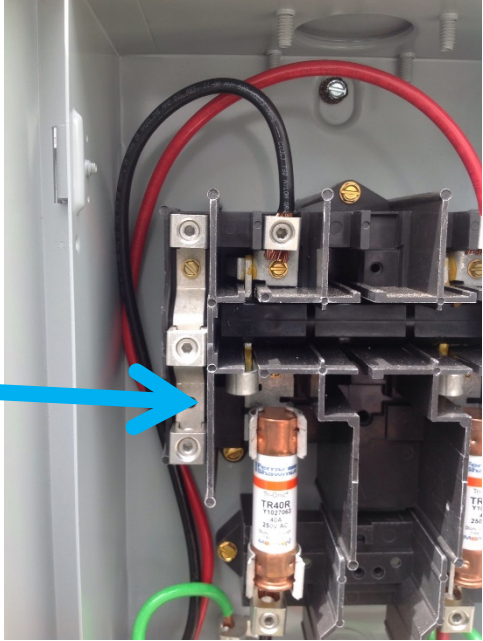
<p><b>Frequency</b> 22 Observations</p>	
<p><b>Potential Impacts</b> When a grounded conductor is not bonded in the PV service disconnect enclosure, it may not have an effective reference if a fault occurs. The main bonding jump helps limit the voltage imposed on the system by lightning or other fault sources.</p>	
<p><b>Best Practices</b> The most common type of connection uses a screw, provided by the disconnect manufacturer. The screw should be installed to bond the grounded conductor to the equipment and grounding electrode system.</p>	

### PV Modules Improperly Secured and Fastened in Place

<p><b>Frequency</b> 8 Observations</p>	
<p><b>Potential Impacts</b> Modules not properly secured to racking pose a risk of falling from the array. These include improper or missing hardware, or modules secured at improper locations.</p>	
<p><b>Best Practices</b> Equipment should be installed in accordance with manufacturers' installation instructions.</p>	

## Array Conductors Improperly Secured and Protected

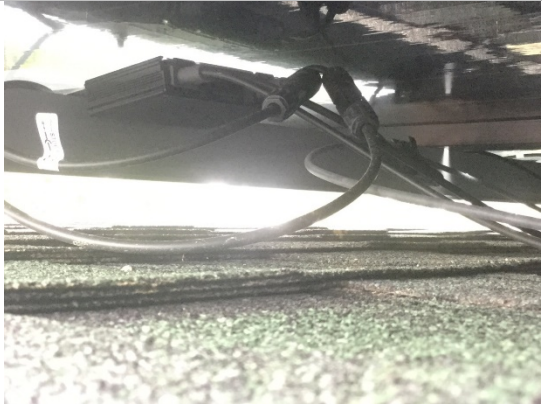
<p><b>Frequency</b> 7 Observations</p>	
<p><b>Potential Impacts</b> Conductors exposed to damage from rooftop debris, sharp edges, and abrasive surfaces may have damaged insulation, increasing the likelihood of a ground fault and shock hazard.</p>	
<p><b>Best Practices</b> To protect them from damage, conductors should be secured using durable methods (such as stainless-steel clips).</p>	

## Failure to Ground Service Disconnect Enclosure

<p><b>Frequency</b> 22 Observations</p>	
<p><b>Potential Impacts</b> Failure to ground service disconnect enclosures can pose personnel risks if a fault occurs.</p>	
<p><b>Best Practices</b> Service disconnect enclosure should be grounded to protect personnel.</p>	

## Missing or Undersized Grounded Electrode Conductor (GEC)

<p><b>Frequency</b> 7 Observations</p>	
<p><b>Potential Impacts</b> For an undersized unit experiencing a fault, a GEC may not carry current or may overheat, creating a potential fire hazard. Grounding must be indicated.</p>	
<p><b>Best Practices</b> Consideration should be given to electrode conductor size. GEC should be green and clearly grounded.</p>	

### Shading and Electricity Generation

As part of Cadmus' inspection protocol under the REG and REF programs, we generate shading reports at each site using Solmetric SunEye technology. These reports assess solar access and shading obstructions for a site to produce a metric known as the Total Solar Resource Fraction (TSRF), which directly influences total onsite solar production efficiency. TSRF values range from 0% to 100%, and solar PV incentive programs can use them as eligibility requirements. The REF program has an 80% minimum TSRF requirement. Although homeowners may not know the actual value, they can be confident that the production estimate provided by the installer will incorporate a TSRF at 80% or higher. Figure 5 also shows an example skyline analysis from a small-scale solar REG inspection.

**Figure 3. Example Skyline Generation from REG SunEye Report**

**Sky01 -- 6/18/2019 12:05 -- (no skyline note)**

**Panel Orientation:** Tilt=18° -- Azimuth=225° -- **Skyline Heading=180°**

**Solar Access:** Annual: 97% -- Summer (May-Oct): 98% -- Winter (Nov-Apr): 95%

**TSRF:** 89% -- **TOF:** 91%

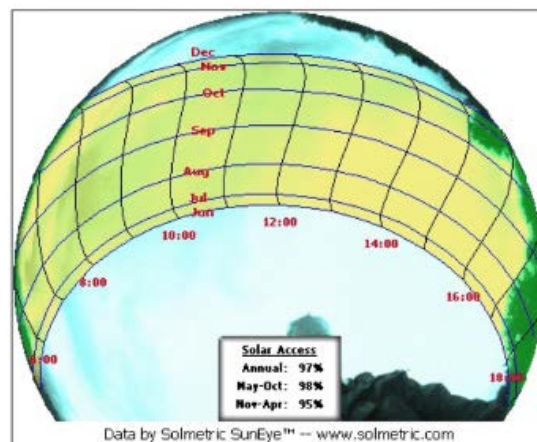

Unlike the REF program, the REG program does not include a minimum shading or TSRF requirement. Overall, of 80 inspections performed, 28 systems had a TSRF less than 80%. No particular installers were responsible for a larger proportion of the low-TSRF sites. Unlike the results found during our 2018 study, there was no relationship between low TSRF values and low-volume installers.

**Table 10. Low TSRF Values for REG Inspections**

Cadmus ID	TSRF
REG192646	77%
REG193425	77%
REG193005	76%
REG193225	76%
REG192647	76%
REG192980	76%
REG193254	75%
REG193296	75%
REG193269	74%
REG193269	74%
REG193227	74%
REG192633	73%
REG192633	73%
REG193300	72%
REG193391	72%
REG193668	72%
REG193644	70%
REG193076	70%
REG193644	69%
REG193185	68%
REG192972	67%
REG193639	67%
REG193217	65%
REG192851	62%
REG193675	62%
REG192634	60%
REG192693	60%
REG192800	59%
REG192886	55%

## Comparisons to 2018 REG Study

In 2018, Cadmus performed a study of renewable energy installation quality in the REG program, assessing REG systems installed under tariff years 2017 and 2018 (the 2018 study). The Rhode Island PUC published the study results in November 2018.<sup>7</sup>

In the 2018 study, the program-wide weighted score average was 2.81 compared to the 2019 study’s weighted average of 3.43. However, the majority of the systems inspected under the 2019 study came online under Tariff Year 2018 due to the relatively low adoption rate of small-scale projects in 2019.

**Table 11. Sample Breakdown by Tariff Year**

Tariff Year 2018	Tariff Year 2019
94%	6%

Similarly, Figure 4 and Figure 5 demonstrate marked improvements in inspection scores. Nearly one-half of the total inspections performed in Round 3 of the 2019 REG quality study received a quality score of 4 or higher—an increase of 13% from that seen during the 2018 study.

**Figure 4. 2018 Score Summary**

■ 1 ■ 2 ■ 3 ■ 4 ■ 5

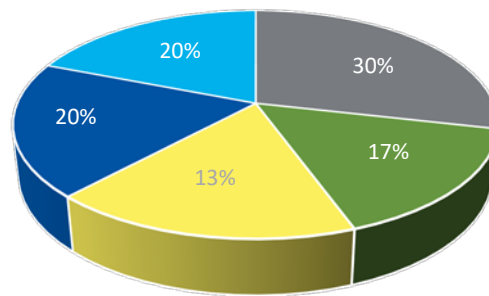

<sup>7</sup> The Cadmus Group, LLC. *Study of Renewable Energy Installation Quality in the Renewable Energy Growth Program*. 2018. Available online: <http://www.ripuc.org/eventsactions/docket/4892-DGBoard-CadmusStudy-Nov5-2018.pdf>.

Figure 5. 2019 Score Summary

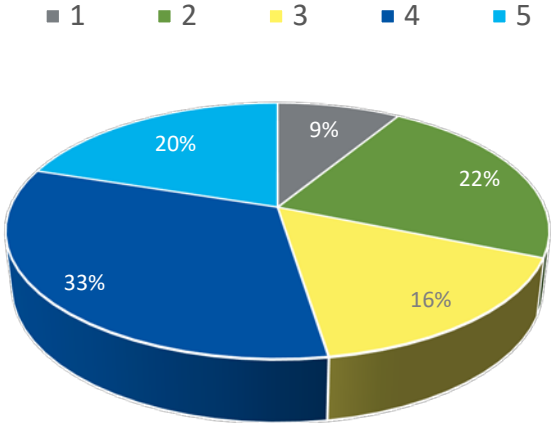

In addition, Cadmus observed that total citations in 2019 decreased compared to last year’s study. Table 11 illustrates an overall drop in minor and major defects, decreasing from 60% of all inspections in 2018 to 33% of these in 2019.

Table 11. Defect Categories as Percentage of Total Citations

Defect Category	2017 Study	2018 Study	2019 Study
Recommendation	3%	1%	1%
Incidental	50%	39%	47%
Minor	35%	43%	27%
Major	11%	17%	6%
Critical	1%	0.6%	1%

For installers inspected as part of the 2018 and 2019 REG installation quality studies, Cadmus found 2019 scores improved over 2018 scores. Figure 6 shows the 2018 and 2019 scores for these installation companies. On average, inspection scores for these installation companies were 28% higher for projects inspected under the 2018 study.



Figure 6. Average Score Comparison Under 2018 and 2019 REG Quality Studies for Selected Installers

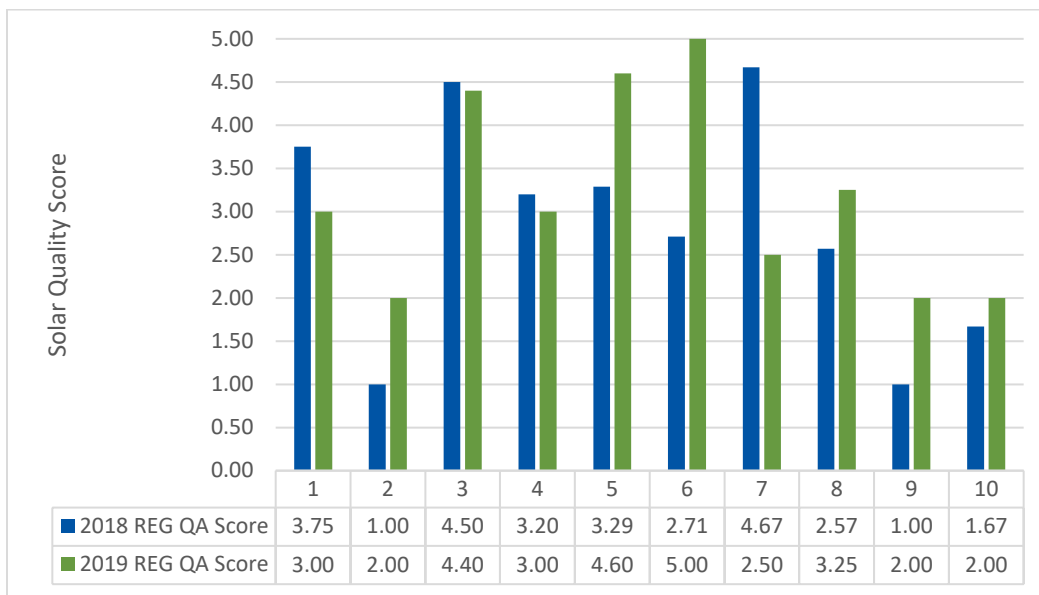

### Comparisons to the REF Program

The Rhode Island Commerce Corporation administers the REF program, a grant and loan incentive program. Cadmus facilitates QA inspections as a program entry requirement, including an inspection and implementation of the corrective action process, if warranted, for all REF-funded systems.

Sites installed under the REF program (during a similar timeframe to REG sites inspected through this study [tariff year 2018 and 2019]) reflected a 3.54 overall quality score. Comparatively, the 2019 REG study's overall weighted quality score was 3.44.

Our 2019 interim results included system inspections for 11 installers unique to the REF program, and therefore not participating in the QA inspections process through REF. Notably, non-REF participating installers achieved a 2.72 average quality score (see Table 13), while installers previously participating in the REF program had an average quality score of 3.14.<sup>8</sup> This score discrepancy may reflect a larger breadth of code and best-practice knowledge in REF-participating installers, through direct involvement with the program's rigorous QA process.

<sup>8</sup> This average reflects all installers who participated in the REF program, including those inspected outside of the REG installation period of tariff year 2018.

**Table 12. Installer Average Quality Scores for Non-REF Program Participants**

Installer ID	2019 REG QA Score
1062	4.0
1004	4.0
1049	1.0
1061	3.5
1066	1.0
1073	1.0
1063	4.0
1075	1.0
1037	2.0

### Medium Solar PV System Findings

#### Technical Findings

The study’s technical outcomes include findings related to physical installations inspected, as summarized below. These include Cadmus’ assessment of installation quality, code compliance findings, and discussions of energy yield and shading issues.

#### Overall Installation Quality Scores

Cadmus calculated the average quality score for medium-scale projects inspected through this study. Overall, approximately 86% of systems inspected received a quality score of 4 or higher, indicating inspections of high-quality installations as shown in Table 14. There was only one system that had at least one major deficiency noted during inspection.

**Table 13. Solar Quality Score Summary (Medium-Scale)**

Solar Quality Score Summary		
Score	Inspection Criteria	Count
1	System has critical and/or multiple major deficiencies	0
2	System has at least one major deficiency	1
3	System has multiple minor deficiencies	0
4	System has minor and/or incidental deficiencies	7
5	System as no or only incidental deficiencies	0

As Cadmus designed the sampling process to distribute study resources across as many installers as possible, the average score presented does not fully represent the actual population of REG projects; rather, it represents the average across projects inspected for this study.

## By Installer

The average quality score per installer varied throughout the study's course, with the lowest scoring installer's average at 2.0 and the highest average at 4.0, as shown in Table 15.

**Table 14. Medium-Scale Inspection Scores by Installer**

Installer	Number of Inspections	Average Score
1053	4	4
1079	3	4
1085	1	2

## Most Common Installation Issues

For the eight medium-scale inspections completed for this study, Cadmus found 13 installation issues, with all 13 of these violating relevant codes and standards. The majority of issues occurred at the array or the AC combiner, as shown in Table 16.

**Table 15. Summary of Inspection Issues Found by Defect Category and Inspection Element (Medium-Scale)**

Inspection Element	Recommendation	Incidental	Minor	Major	Critical	Total
AC Combiner	0	6	4	0	0	10
AC Disconnect	0	0	0	0	0	0
Array	0	0	0	0	0	0
Inverter	0	0	0	0	0	0
Junction Box	0	0	3	0	0	3
Optimizer	0	0	0	0	0	0
Overall Observations	0	0	0	0	0	0
Production Meter	0	0	0	0	0	0
<b>Total</b>	<b>0</b>	<b>6</b>	<b>7</b>	<b>0</b>	<b>0</b>	<b>13</b>

## *Examples of Common Installation Deficiencies*

In this section, Cadmus summarizes the most common installation deficiencies found during the study.

### **Missing of Labeling at Location of Power Source/Disconnects**

#### **Junction Box Wiring Violation**

<p><b>Frequency</b> Five Observations</p>	
<p><b>Potential Impacts</b> Due to the fact that junction box splice components are not listed for or rated for wet location use, corrosion from the environment will create additional resistance and may eventually lead to a fire hazard.</p>	
<p><b>Best Practices</b> Wiring within junction boxes should always be rated for its environment.</p>	

## AC Combiner Warning Label Violation

<p><b>Frequency</b> Four Observations</p>	
<p><b>Potential Impacts</b> Improper labeling of AC combiner, in this case in a matter that is not suitable for environment (permanent marker), which if faded or removed could cause potential personnel hazard onsite.</p>	
<p><b>Best Practices</b> Utilization of proper NEC rated labeling indicator(s).</p>	

## Large Solar PV System Findings

### Technical Findings

The study’s technical outcomes are findings (summarized below) related to physical installations inspected. These include Cadmus’ assessments of installation quality, code compliance findings, and discussions of energy yield and shading issues.

### Overall Installation Quality Scores

Cadmus calculated the average quality score for large-scale projects inspected through this study. Overall, as shown in Table 17, 25% of systems inspected received a quality score of 2, indicating the presence of major and/or critical installation deficiencies.

**Table 16. Solar Quality Score Summary (Large-Scale)**

Solar Quality Score Summary		
Score	Inspection Criteria	Count
1	System has critical and/or multiple major deficiencies	0
2	System has at least one major deficiency	1
3	System has multiple minor deficiencies	1
4	System has minor and/or incidental deficiencies	0

5	System as no or only incidental deficiencies	2
---	--	---

As Cadmus designed the sampling process to distribute study resources across as many installers as possible, the average score shown above does not fully represent the actual population of REG projects—rather, it only describes the average across projects inspected for this study.

### *By Installer*

Though the average quality score per installer varied throughout the study’s course, the lowest scoring installer’s average was 2.0, with a highest average was 5.0, as shown in Table 18.

**Table 17. Large-Scale Inspection Scores by Installer**

Installer ID	Average Score
1084	5.00
1083	5.00
1085	2.00
1086	3.00

### *Most Common Installation Issues*

For the four large-scale inspections completed for this study, Cadmus found 20 installation issues, with 15 of these violating relevant codes and standards. The majority of the issues occurred at the array. Cadmus also found a significant number of issues at the DC combiner.

**Table 18. Summary of Inspection Issues Found by Defect Category and Inspection Element (Large Scale)**

Inspection Element	Recommendation	Incidental	Minor	Major	Critical	Total
AC Combiner	0	1	0	0	0	1
AC Disconnect	0	0	0	0	0	0
Array	0	2	3	1	0	6
DC Combiner	0	3	2	0	0	5
Inverter	0	2	1	0	0	3
Junction Box	0	0	0	0	0	0
Optimizer	0	0	0	0	0	0
Overall Observations	0	0	0	0	0	5
Production Meter	0	0	0	0	0	0
<b>Total</b>	<b>0</b>	<b>8</b>	<b>6</b>	<b>1</b>	<b>0</b>	<b>15</b>

### *Examples of Common Installation Deficiencies*

In this section, Cadmus summarizes the most common installation deficiencies found through the study.

## Missing or Deficient Labeling of System Components

<p><b>Frequency</b> Four Observations</p>	
<p><b>Potential Impacts</b> Properly labeling system components proves important for the safety of those working on the system. Personnel must know the details and dangers of working on the equipment for safe servicing and maintenance.</p>	
<p><b>Best Practices</b> Enclosures containing circuit breakers should be identified to allow the safe isolation of equipment during maintenance. All equipment should include the required hazard markings, as outlined in the code.</p>	

## Undersized Over-Current Protection Device (OCPD)

<p><b>Frequency</b> One Observation</p>	
<p><b>Potential Impacts</b> If the OCPD is undersized, the inverter output will likely be curtailed when the device rating is exceeded. This has the potential to clip energy production prematurely, impacting potential energy yields.</p>	
<p><b>Best Practices</b> The OCPD device is undersized for the expected output current of the inverters. NEC requires The OCPD should be rated at (inverter output) <math>79.4A \times 1.25 = 99.24A</math> or a 100A breaker, rather than 90A.</p>	

## Wind Turbine System Findings

Cadmus inspected one wind energy facility as part of this study. The inspected facility consisted of a single 3 MW wind turbine with an approximately 100m tower. The switchgear and pad-mounted transformer is shown in the photo below. Based on the inspection, the facility complies with relevant codes, standards and REG program requirements. However, Cadmus did find two incidental issues. Corrosion was found on the third weld joint of the tower and a required instructional plaque was

missing. Cadmus did not deduct from the Quality Score for these deficiencies, and the project received an overall quality score of 4 out of 5.

**Figure 7. Base of Inspected Wind Turbine Generator and Pad-Mounted Transformer**



## *Installer Responsiveness to Quality Installation Issues*

### Installer Efforts to Address Inspection Findings

Following receipt of corrections and subsequent approval by a Cadmus inspector, Cadmus recorded corrective action items as “Final.” There were 19 inspections where installers responded with the appropriate Corrective Action Reports. There were an additional 18 inspections where installers responded that they would make appropriate corrections, but never followed up with a report. The study team found a relatively low rate of response to outreach. Of the 93 sites inspected and contacted, 47 never responded, 34 responded, and 12 sites did not have enough contact information to reach. Of those that responded, as mentioned above, just over half

#### Templated Email from Cadmus to Installer

The score of this inspection and your respective corrective action will not affect your customer’s receipt of their REG incentive from National Grid. However, we are conducting these inspections as part of a study funded by the Rhode Island Office of Energy Resources (OER) to document the quality of installations completed through the REG program. We are collecting data on installation quality, most frequently observed code violations, installer responsiveness to corrective action notices, and anecdotal feedback from customers and installers. These findings will be published in a report given to OER and National Grid, with findings presented to the Rhode Island DG Board. Presumably, the report will be available to the public. It is our intention not to name any particular customers or installers in the report, which will focus on aggregate findings, but OER and National Grid will have access to all documents associated with our findings, including inspection reports and documentation of installer actions taken in response to our findings.



responded with appropriate correction reports. On average, it took 9.75 days to respond to our outreach. On average, of those who responded with corrective actions, it took 10.15 days.

The corrections timeline fell by the second reminder, about 63% of responses came after the second reminder. This indicates installers uncommonly respond on the first communication. Of the 34 responses, only 55.9% responded with corrective actions.

**Figure 8. Outreach before Installer Response**

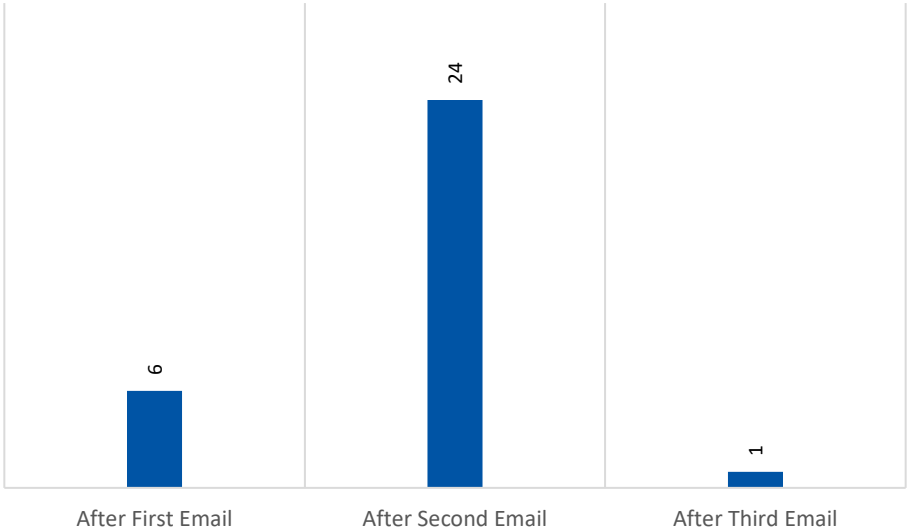

Most of these responses were inspections that scored a 4, which accounted for 42% of the corrective action response. The next highest response rate by score that scored a 5, which represented 26% of the corrective action responses.

**Figure 9. Installer Responses by Inspection Score**

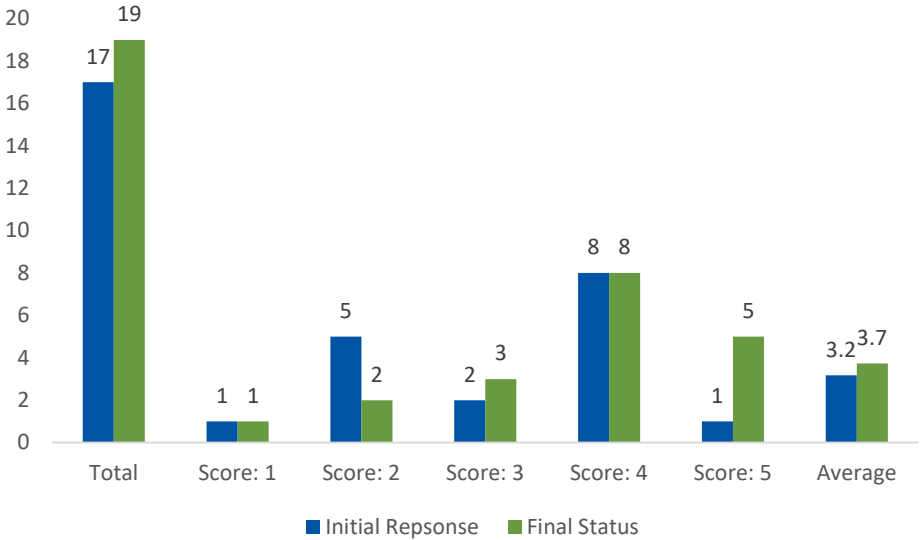

In general, of the inspected sites contacted, the average score of inspections was 3.3. Of the sites inspected, there were 25 different installers. There were a total six inspections providing a score of 1, 20 inspections that provided a score of 2, 15 inspections that provided a score of 3, 32 inspections that provided scores of 4, and 12 inspections that provided a score of 5.

## Customer Survey

To augment findings from on-site inspections, Cadmus conducted an online survey of REG customers in the small solar category. Conducted in parallel with the on-site inspections, the survey targeted 906 REG participants with systems interconnected under the REG program within Tariff Year 2018 and 77 REG participants under the REG program within Tariff Year 2019. The survey addressed questions such as:

- How satisfied are REG customers with their installer’s customer service and installation quality?
- How educated are REG customers regarding the REG program?
- What types of quality concerns are customers experiencing with their REG-supported installation?

To incentivize responses, Cadmus awarded a \$100 gift card to one randomly selected survey participant. The survey prompted 235 complete responses, with results aggregated in this section. Of the participants, 85% of respondents were those with small-scale systems installed under Tariff Year 2018 and 15% of respondents were those with small-scale systems installed under Tariff Year 2019.

## Customer Feedback on Installer

Survey respondents were asked to rate their satisfaction with their system installer, particularly regarding the installer’s performance in conducting physical installations and their customer service. Respondents were asked to rate their installers on a scale from “very satisfied” to “not satisfied at all” for the following two questions:

1. How would you rate your satisfaction with your installer’s performance in installing your system?
2. How would you rate your satisfaction with your installer’s customer service (e.g., responsiveness to questions and concerns, clarity, and timeliness of communication)?

Cadmus used responses to both questions as indicators of overall satisfaction with installer’s performance. The 220 unique responses to these two questions indicated largely positive customer satisfaction levels with installers across the REG program, with 87% of answers falling in the “satisfied” categories, as seen in Figure 15. Participants responding “Don’t know” were marked as having neutral impressions.

**Figure 9. Customer Satisfaction with Installer Performance**

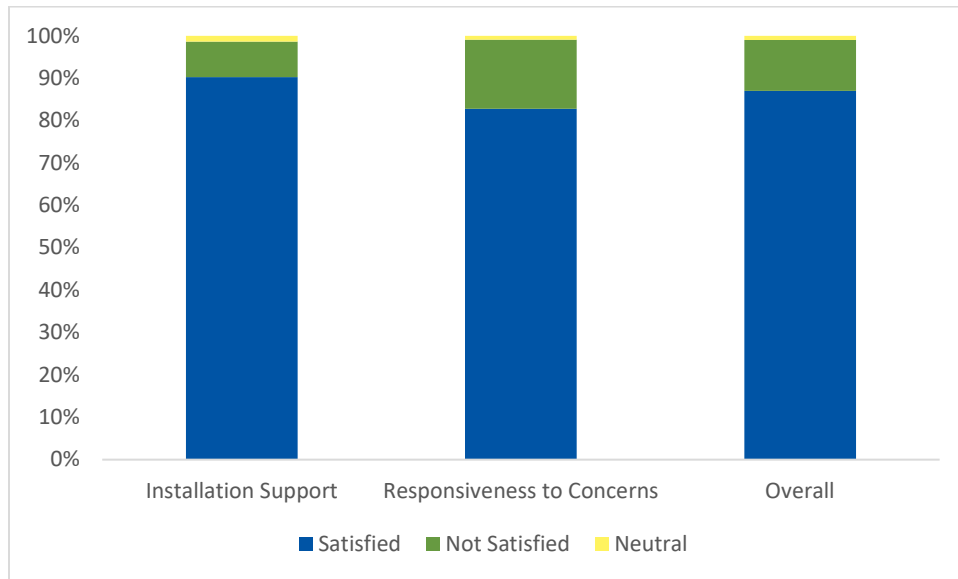

REG participants exhibited favorable impressions of their installer’s performance in this year’s survey with customer satisfaction measured at 87%. For comparison, similar statistics from the 2017 and 2018 studies measured customer satisfaction at 45% and 87% respectively.

**Performance and Benefit Expectations**

Some negative survey responses related to systems with unmet system performance expectations, REG payment expectations, or both. Cadmus asked respondents to answer the following two questions about their system’s output and payments.

1. To respondents saying their REG payments were inconsistent with their expectations: How different are the REG payments generated by your system compared to what you anticipated?
2. How does the system’s production/energy output compare with what you expected?

Questions 1 and 2 were answered on the scale shown in Table 20.

**Table 19. System Payment and Output Scale of Responses**

System Payment and Output Scale
Slightly Lower than Expected
Much Lower than Expected
As Expected
Slightly Higher than Expected
Much Higher than Expected

Of the 216 respondents, 57% reported having system production levels as expected or higher. 24% of respondents had production levels “slightly lower than expected” and 7% had production levels “much lower than expected”.

As REG payments depended on energy production, a system producing less energy than expected resulted in lower-than-expected payments, leading to some overlaps in these two statistics. 9% of the

66 responses to question 1 indicated that the REG payments were higher than expected, 56% of respondents indicated that REG payments were “slightly lower” than expected, and 35% of respondents indicated that payments were “much lower” than expected.

Figure 10 shows customer responses to question 2 grouped by 19 different installers. Here we see that customer satisfaction levels with their systems production levels are not directly tied to installers. However, we can identify some installers that have several customers that have indicated that their production levels are lower than expected.

**Figure 10 How does the system's production/energy output compare with what you expected?**

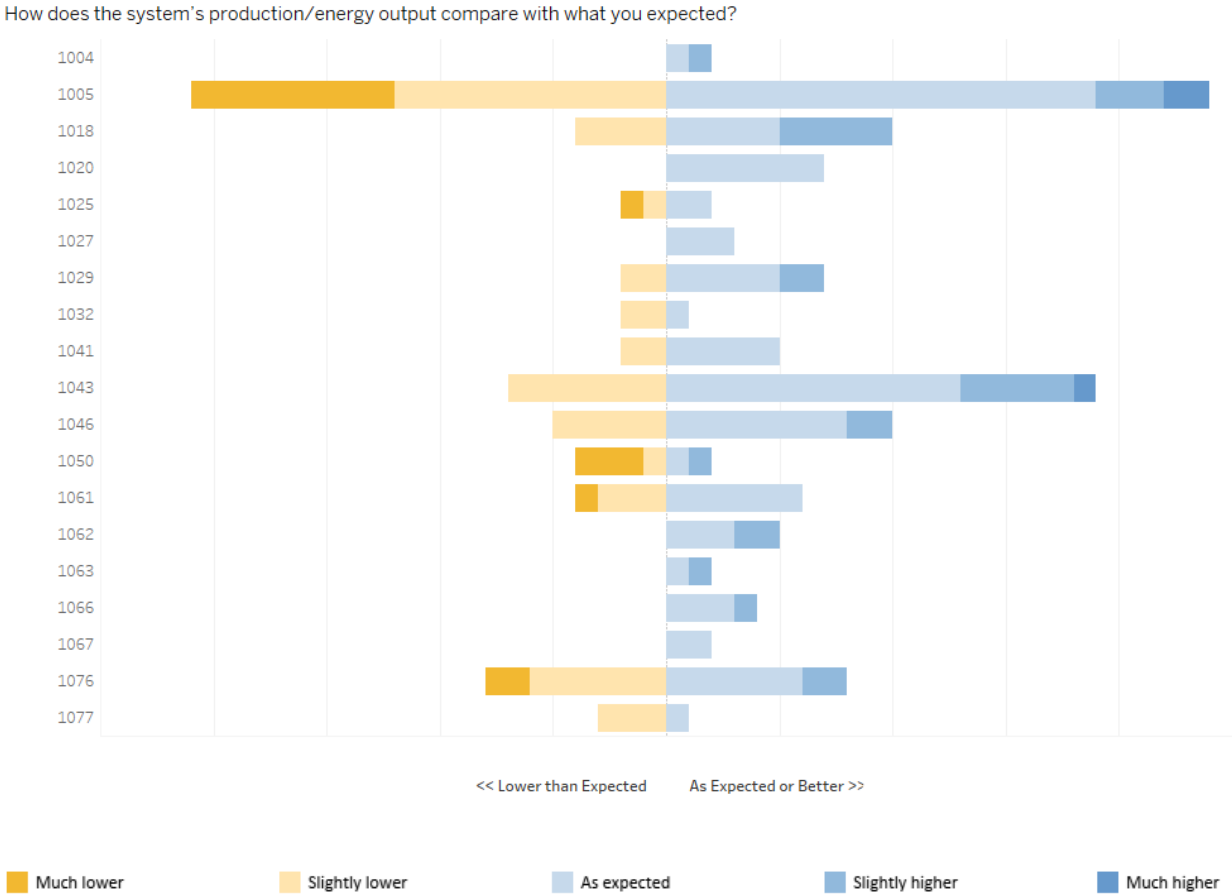

Cadmus asked survey respondents to answer the following question about the percentage of their monthly bill that the REG credits cover:

- Approximately what percentage of your average total monthly electric bill over the course of an entire year is covered by your REG bill credits and payments?

Figure 11 shows the distribution of answers to that question. 63% of customers indicated that their solar installations generated bill credits that cover over 50% of their total monthly bills. Customers who have

solar installations that generate bill credits that cover less than 50% of their monthly bills are more likely to be dissatisfied with various aspects of their system.

**Figure 11** Approximately what percentage of your average total monthly electric bill over the course of an entire year is covered by your Renewable Energy Growth bill credits and payments?

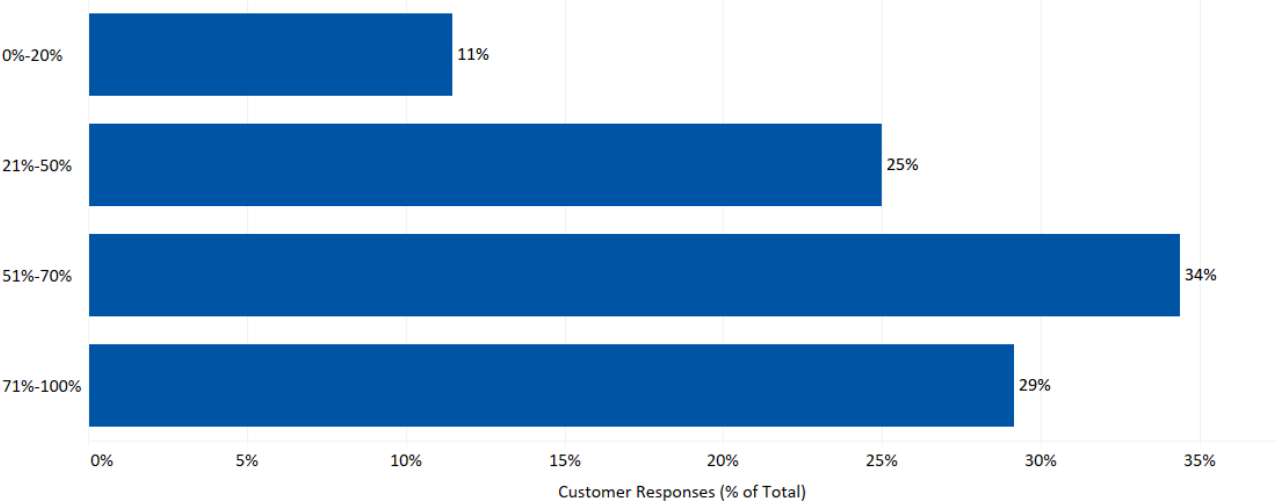

**Programmatic Timelines**

Of 218 responses, 35 customers indicated that they had unscheduled system maintenance or downtime. Customers were able to describe the cause of their delays in the survey. The three biggest contributors to delays were: problems with the panels, problem with the monitoring system and problems with the inverters as shown in Figure 12.

**Figure 12** You indicated that you have had unscheduled system maintenance or downtime since your system was installed. Please describe the maintenance or downtime issue(s).

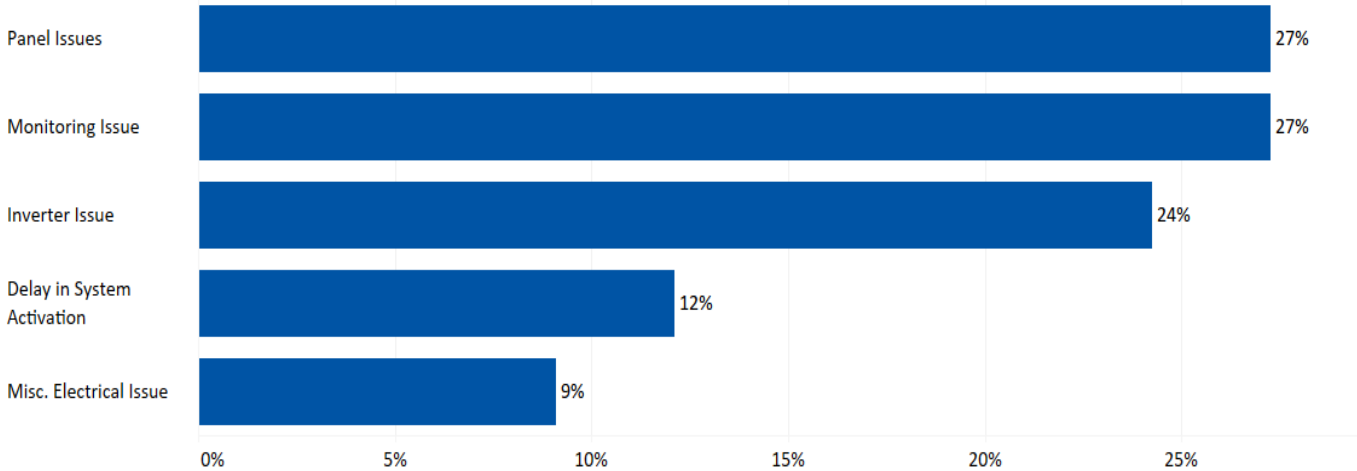

## Roof Age

The National Roofing Contractors Association recommends that PV systems should only be installed on roofs with an expected service life at least as long as the solar components.<sup>9</sup> Solar PV installations on a roof with a shorter life expectancy can pose safety and warranty concerns, including roof leaks or collapses, or costly system removal and reinstallation to accommodate roof replacements.

A rooftop solar PV installation has a useful life of 20 to 25 years, with a typical warranty of 10 years. As asphalt shingle roofs have a 20-year life expectancy on average,<sup>10</sup> best practice dictates solar PV should not be installed on homes with roofs older than approximately five to eight years. Though installing units on a new roof is ideal, this is not always possible. The older the roof, however, the greater the chance for a potential roof failure or a PV system requiring removal to facilitate a roof replacement (and ultimately reinstallation). PV system purchase prices rarely include removal and reinstallation costs.

Survey respondents were asked to report the approximate age of their roof and recall whether their system installer discussed the possibility of removal for roof replacement.

3. If your renewable energy installation is installed on your roof, what was the age of your roof at the time of installation?
4. Did your installer discuss the possibility of having to move the system to facilitate roof replacement at some point in the next 20 years?

Survey results revealed a relatively significant number of REG program participants that installed solar PV systems on older roofs. Specifically, 20% of survey respondents had solar PV systems installed when their roof was over eleven years old, with some respondents' roofs over 16 years old at the time of installation as shown in Figure 13.

---

<sup>9</sup> National Roofing Contractors Association. *NRCA Guidelines for Rooftop-mounted Photovoltaic Systems, Second Edition*. 2018. <https://www.nrca.net/store/detail/nrca-guidelines-for-rooftop-mounted-photovoltaic-systems-second-edition/1745>

<sup>10</sup> National Association of Home Builders/Bank of America Home Equity. *Study of Life Expectancy of Home Components*. February 2017. <https://www.interstatebrick.com/sites/default/files/library/nahb20study20of20life20expectancy20of20home20components.pdf>

Figure 13. Roof Age at Time of Install

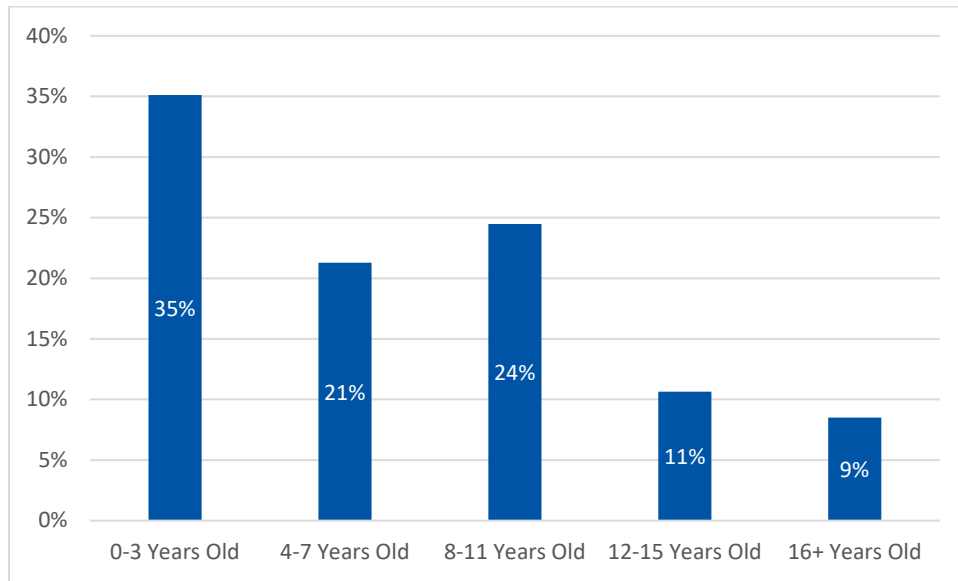

In some cases, customers may decide to move forward with solar PV installations on older roofs after weighing the installation’s costs and benefits and its corresponding warranty and safety implications. If roof replacements may occur during the working life of the solar panels, the cost of removing and reinstalling panels may be specified in the solar PV installation contract. **Error! Reference source not found.** illustrates the percent of customers indicating that their installer discussed that the possibility of having to move the system to facilitate roof replacement during the contract term increased with age of the customer’s roof.

### New Installer Webinar Response Survey

Cadmus created and sent out a survey to new installers who completed the New Installer Training Webinar. The survey was sent to 19 participants with only one response. Due to the lack of data, Cadmus was not able to draw out any meaningful conclusions from this survey.

## Conclusions and Recommendations

The 2019 REG installation quality study results and findings indicate that most REG-funded, renewable energy installations did not achieve “safe, high-quality, performing as expected, and in conformance with the stated specifications.”<sup>11</sup> In fact, only 20%<sup>12</sup> of 80 small solar installations inspected met these criteria.

Consequently, Cadmus recommends that OER, National Grid, and the PUC consider a range of educational and programmatic recommendations to improve future installation quality. In offering the recommendations that follow, Cadmus remained cognizant of solar soft cost impacts on Rhode Island’s solar PV market and offered suggestions that would not unduly increase these costs.

This study organizes these recommendations by priority (i.e., low, medium, or high), determining the levels based on anticipated impacts and timelines to complete the recommendation (as shown in Table 21).

**Table 20. Prioritization of Recommendations by Anticipated Impact and Timeline**

Impact ↑	High Priority	Medium Priority
	Medium Priority	Low Priority
Timeline →		

### High-Priority Recommendations

Cadmus considered recommendations as high priority if it appeared to have a higher impact and a shorter implementation timeline (less than six months).

#### Collect and Report Additional Data Related to Installation Quality

On the REG interconnection application, National Grid collects several data points, primarily related to customer information and system details. This application process can be used to gather data points related to system quality. Specifically, Cadmus recommends two additions:

- **Electrician Information.** National Grid currently requires reporting the general contract number on the interconnection application. To track quality and ensure installations by licensed individuals, additional information on the installing electricians would be beneficial. Specifically, we recommend gathering the electrician’s name, company, and license number.
- **Estimated System Production.** In order to offer more transparency for customers, we recommend requiring collection of system performance information, such as module and inverter information and estimated annual production.

<sup>11</sup> A metric specified by the OER in RFP 7549810, *Solar Quality Assurance Inspection Study and Report*.

<sup>12</sup> This figure represents renewable energy systems receiving a score of 5, indicating the systems had no or only incidental deficiencies.



These additional data points should be reported to OER on a monthly basis, along with other interconnection details.

**Responsible Party:** OER.

## Offer Training to Local Electrical and Building Inspectors

The inspections that Cadmus performed for this study followed approval by local authorities with jurisdiction. Based on the number of violations Cadmus identified in previously approved systems, local electrical and/or building inspectors often could not identify noncompliance. These inspectors' jobs neither focused on renewable energy systems nor included information about renewable energy systems as a required aspect of their electrical training or certification.

As such, Cadmus recommends further training for local electrical and building inspectors, particularly regarding solar PV and REG metering requirements. Training and technical support materials should provide clear guidance, including photos and diagrams, that local inspectors can easily understand, and reference as needed. Cadmus recommends offering these trainings in person, based on past experiences with training electrical and building inspectors.

**Responsible Parties:** OER.

## Offer Training to Renewable Energy Installers

The number of installation violations identified in this study (to date) revealed that installers did not complete code- and/or REG-compliant renewable energy systems. Installer feedback in response to inspection reports, whether presented as questions to Cadmus or through completion of corrective actions, suggests that installers often remain unaware that their installations are noncompliant.

As such, Cadmus recommends that National Grid and/or OER offer training and training materials to installers currently installing renewable energy systems through the REG program. The training should be specific to installation issues identified in Rhode Island and within the REG program. Further, trainers should present REG interconnection requirements clearly and in detail. Training and training materials should provide clear technical guidance, with photos and diagrams easy for installers to understand and reference, as needed. Cadmus recommends combining in-person (e.g., during Rhode Island Solar Stakeholder meetings) and web-based trainings to maximize training opportunities for this audience. Regarding web-based training, Cadmus further recommends using a combination of comprehensive, multi-hour trainings, and short, topical trainings to address all types of knowledge gaps.

**Responsible Party:** OER.

## Medium-Priority Recommendations

Cadmus considered recommendations medium priority if anticipating they had a lower impact, with a shorter implementation timeline (less than six months), or a higher impact, with a longer implementation time (greater than six months).

### Implement Use of a Customer Disclosure Form

The addition of a solar customer protection disclosure form to REG program requirements would allow future studies to consider the total cost of REG systems against the total quality of installations. The proposed customer protection form would establish key responsibilities regarding system installation and maintenance between installers and system owners as well as the ownership of incentives. Additionally, the form would require information regarding a customer's contract, project cost, size, and estimated year 1 production, provided by the installer's proposal. Implementing this form will allow more transparency between installers and customers regarding performance and REG payment expectations.

### Conduct Ongoing REG Quality Assurance Reviews

Based on the study findings, Cadmus recommends conducting some level of ongoing QA review for REG-funded renewable energy installations. Specific considerations follow for ongoing REG program QA reviews.

#### *Sampling Rate*

OER, National Grid, and the Rhode Island PUC should consider the extent and frequency of QA inspections. Cadmus does not recommend inspecting 100% of systems (as the REF program requires) due to current and future high-installation volumes for the REG program. Rather, we suggest applying smart or targeted sampling for higher-risk installations (e.g., low-volume or self-installers) and spot-checking for high-volume installers.

In particular, Cadmus recommends implementing a systematic, high-volume installer plan, in which installers with a designated number of installations and a proven track record of quality installations are subject only to random sampling. A high-volume installer plan would allow OER and National Grid to focus their resources most effectively by devoting greater technical resources to installers struggling to properly complete installations, rather than continuing to inspect experienced, high-performance installers.

To supplement this sampling approach, Cadmus recommends assessing the feasibility of a photo-based inspection process for REG-funded installations. Through this process, installers submit specific photographs of completed installations for review and approval (rather than performing in-person inspections). Desktop inspections can often be completed at a fraction of a field inspection's cost.

#### *Program Feedback*

Cadmus recommends incorporating an additional component into ongoing QA reviews: formal collection and analysis of REG program feedback from customers, installers, local electrical/building inspectors, National Grid, OER, and the PUC. We anticipate that Cadmus can efficiently gather feedback from installers and customers through online surveys, while collecting feedback from local electrical/building inspectors, National Grid, OER, the PUC, and other stakeholders through phone surveys or more detailed interviews.

OER and National Grid can use such feedback to accomplish the following:

- Improve the customer’s experience
- Inform annual ceiling price analysis
- Identify knowledge gaps and education needs

**Responsible Parties:** OER.

## *Low-Priority Recommendations*

Recommendations considered low priority are those anticipated to have lower impacts and longer implementation timelines (greater than six months).

### **Continue to Enhance Program Minimum Technical Guidance**

Though Cadmus developed minimum technical guidance for the 2018 REG program year, and further enhanced them in 2019, we recommend further enhancing this document to include new program components such as storage included in the REG tariff language updates. Consequently, we recommend updating this minimum technical guidance regularly (as needed), and clearly communicating these updates to existing program participants (e.g., installers, building/electrical inspectors, National Grid metering staff) to ensure consistency in program installations.

**Responsible Parties:** OER, with support from National Grid.

## *Progress on 2018 Recommendations*

Since 2018, when Cadmus conducted a second study of REG installations, National Grid and OER have made progress on two specific recommendations: requiring training for new program participants; and enhancing the program’s minimal technical guidance.

### **Require Training for New Program Participants**

To proactively train new installers that seek to participate in the REG program, Cadmus developed web-based training, required by new program participants prior to filing an interconnection application for the program. This recorded training addressed REG’s program and metering requirements as well as common installation issues. Available online, installers and their field staff can access the training at any time.

After completing the web-based training, installers certify their completion, and Cadmus provides certification to OER. Cadmus developed and deployed a survey that is presented to webinar participants to gauge their experience and comprehension.

### **Enhance Program Minimum Technical Guidance**

Though Cadmus developed minimum technical guidance for this REG installation quality study, we recommend enhancing this document with future tariff language changes. Cadmus enhanced the MTG for the REG installation quality study at the beginning of 2019’s REG installation quality study. This

document allows clearer communication of OER's and National Grid's expectations for REG-funded renewable energy installations.

## *Additional Progress*

### **Solar Permit Audit**

After the 2018 REG installation quality study, a solar permit audit was added to the program. Through this audit, OER and National Grid can confirm whether a general contractor's number (referenced on permits for REG installations) remains valid and accurate.

### **Mandatory Inspections**

For Tariff Year 2019, inspections became mandatory for all projects participating in the REG program. Updating this tariff language to require all randomly selected program participants to participate in inspections for the installation quality study has allowed easier and more efficient inspection scheduling (given its mandatory nature).

## *Next Steps*

Cadmus recommends that OER and National Grid convene to discuss the findings and recommendations presented in this report. Further, we strongly suggest taking timely action on recommendations to ensure the quality of REG-funded renewable energy installations improves in the near future.